

FRONT VIEW
 18"X18" SIDE HINGED
 A/D U.L. APPROVED

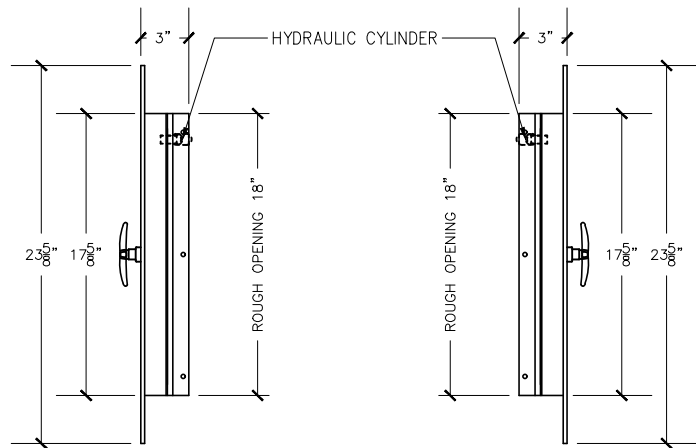

RIGHT VIEW **LEFT VIEW**

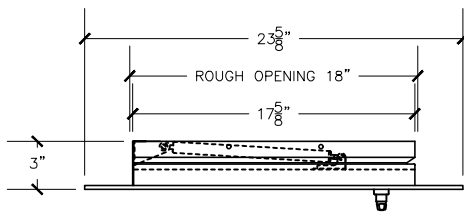

TOP VIEW

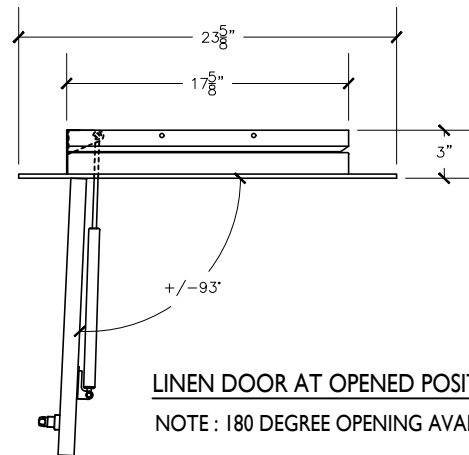

LINEN DOOR AT OPENED POSITION
 NOTE : 180 DEGREE OPENING AVAILABLE

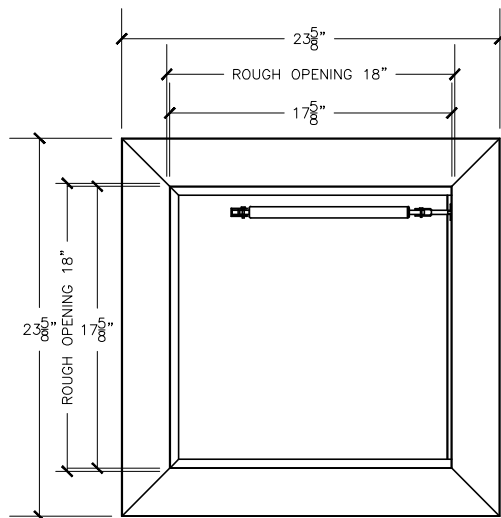

REAR VIEW

NOTE:
 Rough opening required 18"x18"

Linen chute door specifications:

Doors are fabricated with type 304 Stainless Steel, Stainless Steel Hinges, with a self closing, self latching quiet door closing function. Class B labeled: 1-1/2 hour fire rated with 30-minute temperature rise of 250 degrees Fahrenheit and a frame suitable for enclosing multiple type chase construction. Doors are provided with key locking devices at each intake door location. Door trim is embossed "LINEN".

956 Brush Hollow Rd.
 Westbury, NY 11590
 phone: (718) 472-5700
 fax: (718) 472-5813
 website: www.allcitymetal.com
 e-mail: info@allcitymetal.com

ALL-CITY METAL
 SHEET METAL FABRICATORS

LINEN CHUTE INTAKE DOOR
 MODEL # 25L3-90D 18"X18" LD/LH 3" TRIM