

**FRONT VIEW**

18"x18" SIDE HINGED  
A/D U.L. APPROVED

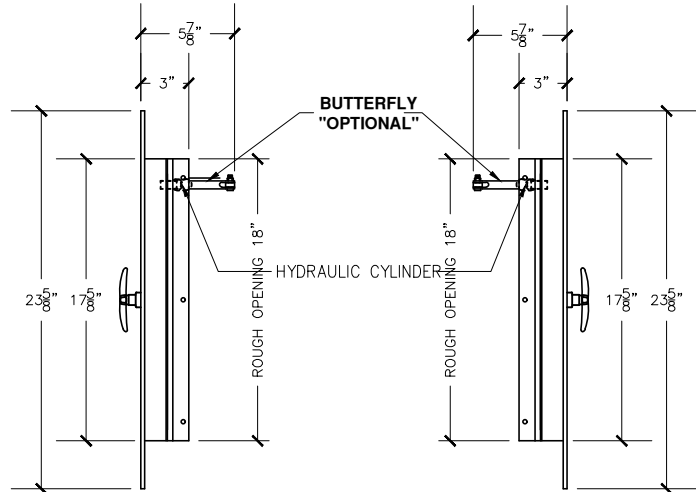

**RIGHT VIEW**

**LEFT VIEW**

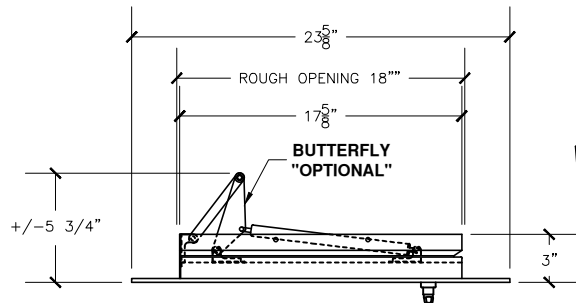

**TOP VIEW**

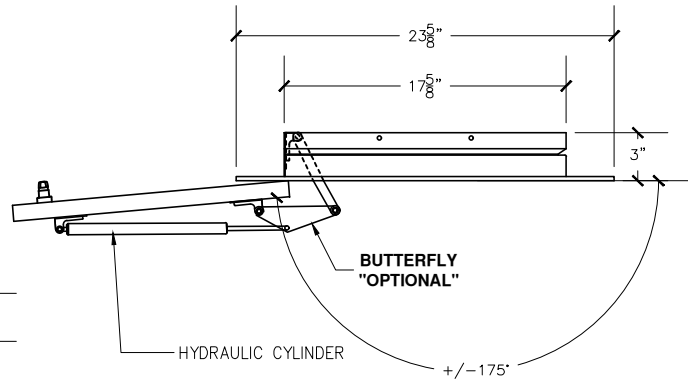

**LINEN DOOR AT OPENED POSITION**

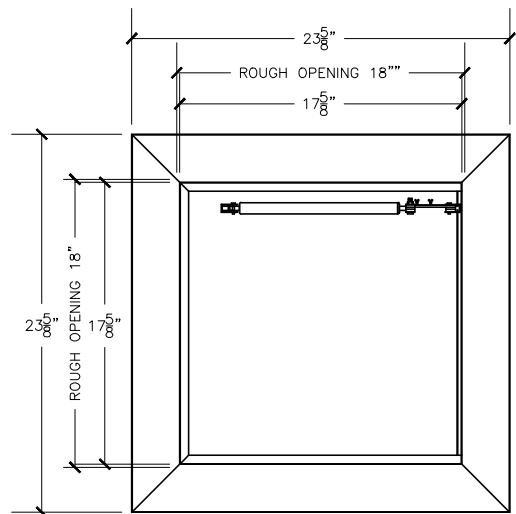

**REAR VIEW**

**Linen chute door specifications:**

Doors are fabricated with type 304 Stainless Steel, Stainless Steel Hinges, with a self closing, self latching quiet door closing function. Class B labeled: 1-1/2 hour fire rated with 30-minute temperature rise of 250 degrees Fahrenheit and a frame suitable for enclosing multiple type chase construction. Doors are provided with key locking devices at each intake door location. Door trim is embossed "LINEN".

**NOTE:**

Rough opening required 18"x18"

956 Brush Hollow Rd.  
Westbury, NY 11590  
phone: (718) 472-5700  
fax: (718) 472-5813  
website: www.allcitymetal.com  
e-mail: info@allcitymetal.com

**ALL-CITY METAL**  
SHEET METAL FABRICATORS

**LINEN CHUTE INTAKE DOOR**  
MODEL # 25L3-180D 18"x18" LD/LH 3" TRIM