

FRONT VIEW

15"X15" SIDE HINGED
A/D U.L. APPROVED

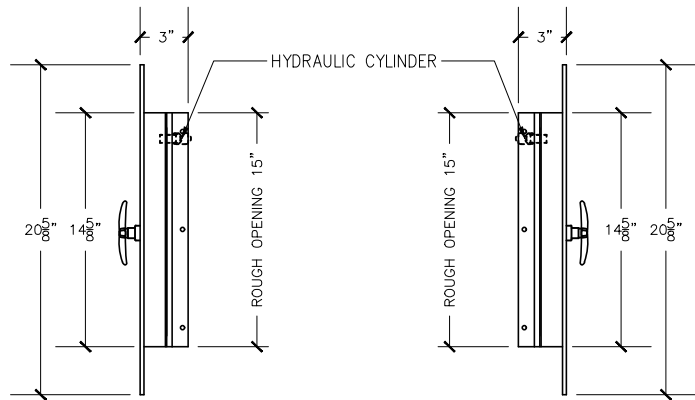

RIGHT VIEW

LEFT VIEW

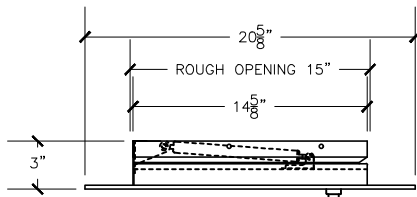

TOP VIEW

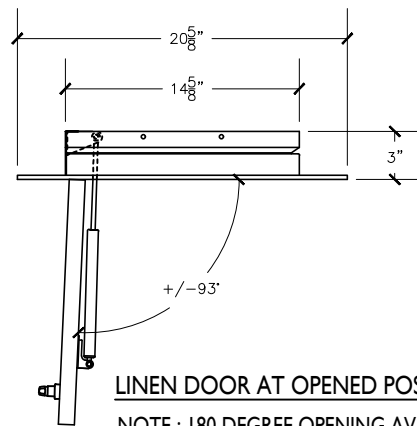

LINEN DOOR AT OPENED POSITION

NOTE : 180 DEGREE OPENING AVAILABLE

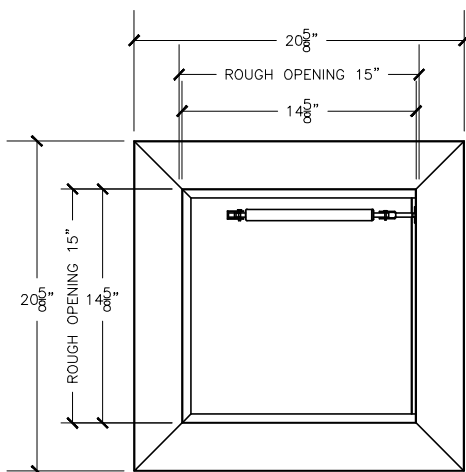

REAR VIEW

NOTE:

Rough opening required 15"x15"

Linen chute door specifications:

Doors are fabricated with type 304 Stainless Steel, Stainless Steel Hinges, with a self closing, self latching quiet door closing function. Class B labeled: 1-1/2 hour fire rated with 30-minute temperature rise of 250 degrees Fahrenheit and a frame suitable for enclosing multiple type chase construction. Doors are provided with key locking devices at each intake door location. Door trim is embossed "LINEN".

956 Brush Hollow Rd.
Westbury, NY 11590
phone: (718) 472-5700
fax: (718) 472-5813
website: www.allcitymetal.com
e-mail: info@allcitymetal.com

ALL-CITY METALTM
SHEET METAL FABRICATORS

LINEN CHUTE INTAKE DOOR
MODEL # 20L3-90D 15"X15" LD/LH 3" TRIM