

FRONT VIEW
 15"x18" BOTTOM HINGED
 A/D U.L. APPROVED
 W/ RUBBER BAFFLE
 (NTS)

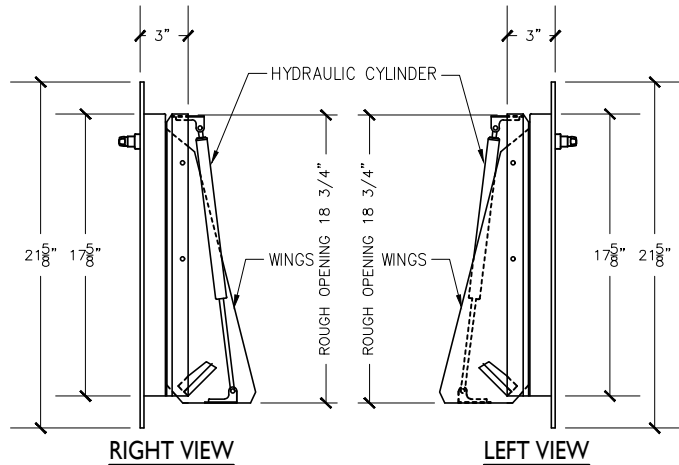

RIGHT VIEW
 RUBBER BAFFLE NOT SHOWN

LEFT VIEW
 RUBBER BAFFLE NOT SHOWN

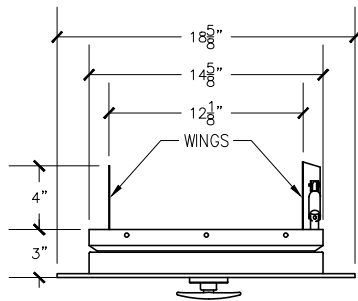

TOP VIEW
 RUBBER BAFFLE NOT SHOWN

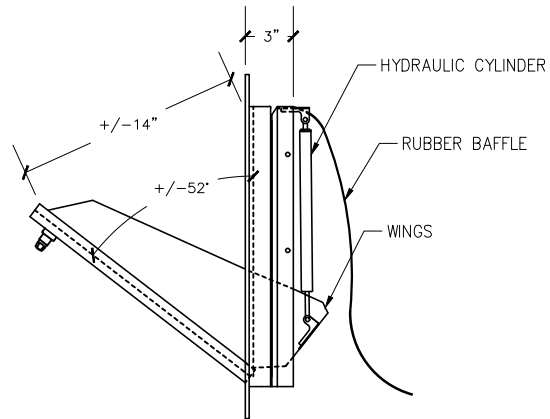

TRASH DOOR AT OPENED POSITION
 WITH RUBBER BAFFLE

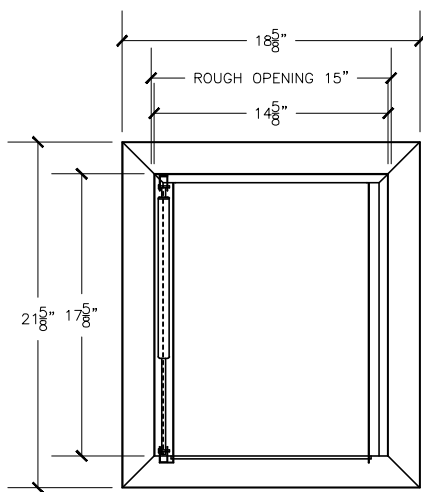

REAR VIEW
 RUBBER BAFFLE NOT SHOWN

Trash chute door specifications:

Doors are fabricated with type 304 Stainless Steel, Stainless Steel hinges, with a self closing, self latching quiet door closing function. Classified 'UL' Class B labeled: 1-1/2 hour fire rated with 30-minute temperature rise of 250 degrees Fahrenheit and a frame suitable for enclosing multiple type chase construction. Doors are provided with key locking devices at each intake door location. Door trim is embossed "**RUBBISH**".

NOTE:

Rough opening required 15"x18 3/4"

54-35 46th Street
 Maspeth, NY 11378
 phone: (718) 472-5700
 fax: (718) 472-5813
 website: www.allcitymetal.com
 e-mail: info@allcitymetal.com

ALL-CITY METAL
 SHEET METAL FABRICATORS

TRASH CHUTE INTAKE DOOR
 MODEL # 35B2 15"x18" TD/BH 2" TRIM