

FRONT VIEW
A/D U.L. APPROVED
24"x24" SIDE HINGED

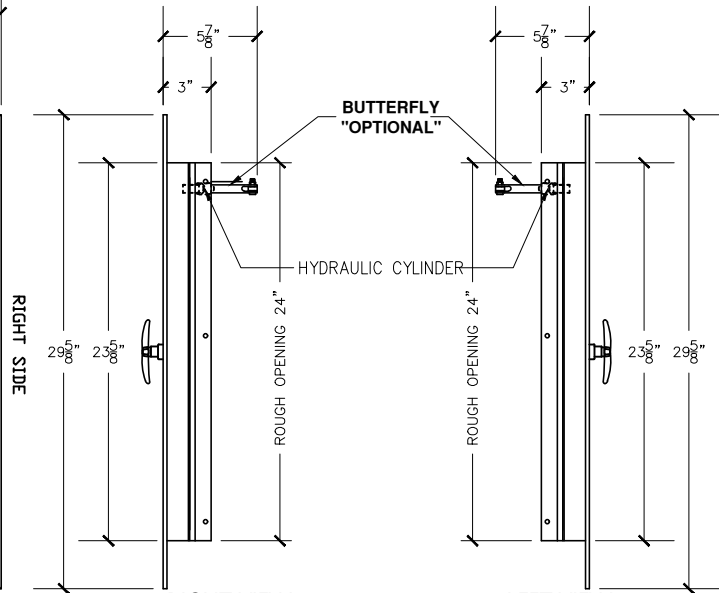

RIGHT VIEW **LEFT VIEW**

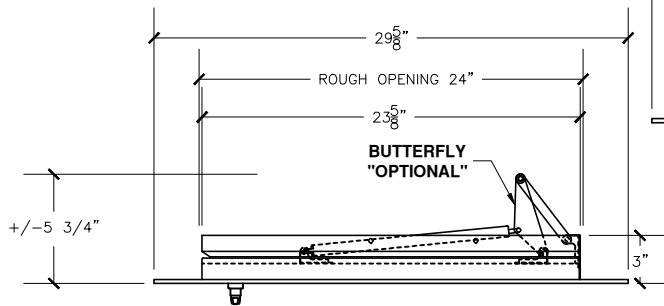

TOP VIEW

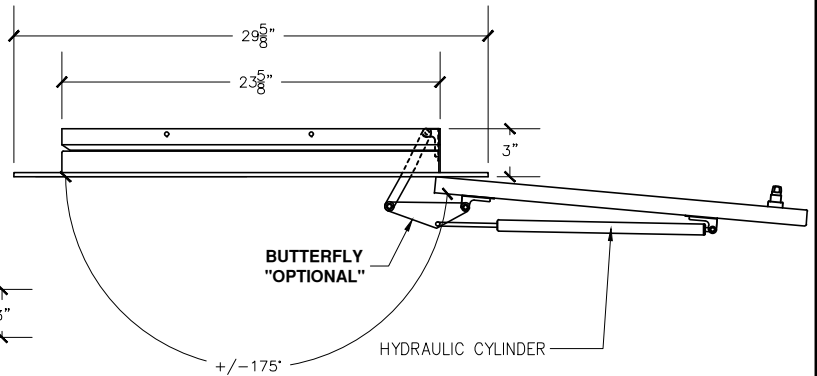

LINEN DOOR AT OPENED POSITION

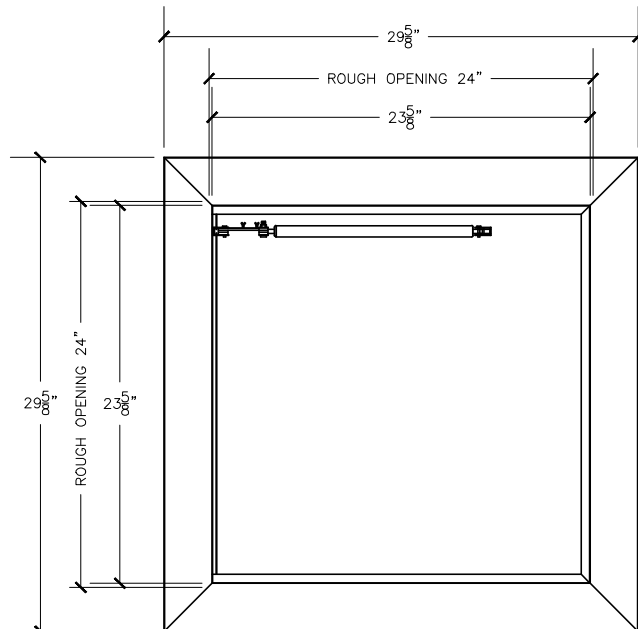

REAR VIEW

NOTE:
Rough opening required 24"x24"

Linen chute door specifications:

Doors are fabricated with type 304 Stainless Steel, Stainless Steel Hinges, with a self closing, self latching quiet door closing function. Class B labeled: 1-1/2 hour fire rated with 30-minute temperature rise of 250 degrees Fahrenheit and a frame suitable for enclosing multiple type chase construction. Doors are provided with key locking devices at each intake door location. Door trim is embossed "LINEN".

54-35 46th Street
Maspeth, NY 11378
phone: (718) 472-5700
fax: (718) 472-5813
website: www.allcitymetal.com
e-mail: info@allcitymetal.com

ALL-CITY METAL
SHEET METAL FABRICATORS

LINEN CHUTE INTAKE DOOR
MODEL # 29L3-180D 24"x24" LD/RH 3" TRIM